

Operation Quick Start Guide V1.0 for

CONNECT-CONTROL-EUROPE CONNECT-CONTROL-WORLD



This page contains the **brief instructions** for the **CONNECT-CONTROL-devices**. Here you will find an overview of the various components on the front and back, basic hardware installation, initial login information, device specifications and general safety instructions. It is highly recommended that you familiarize yourself with the quick start guide before using the device. If you have a **CONNECT-CONTROL-device**, you will also find a printed version of the quick start guide in the device packaging or online on the device's product page.

Connections:

Frontside:

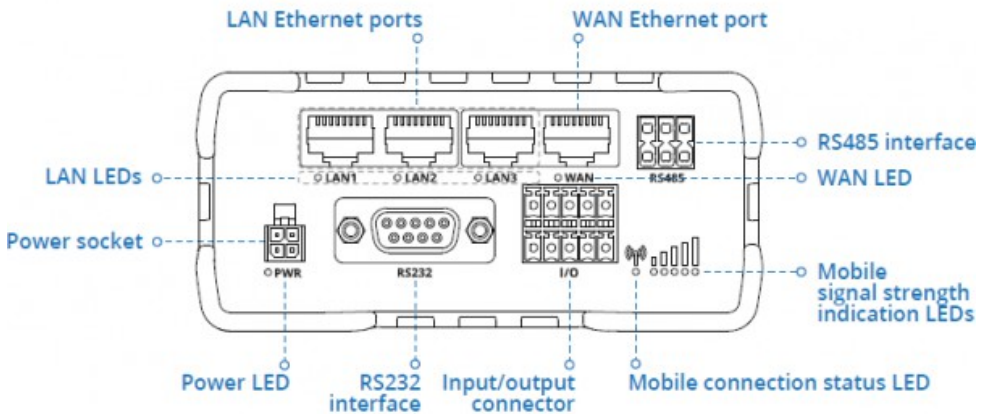

Backside:

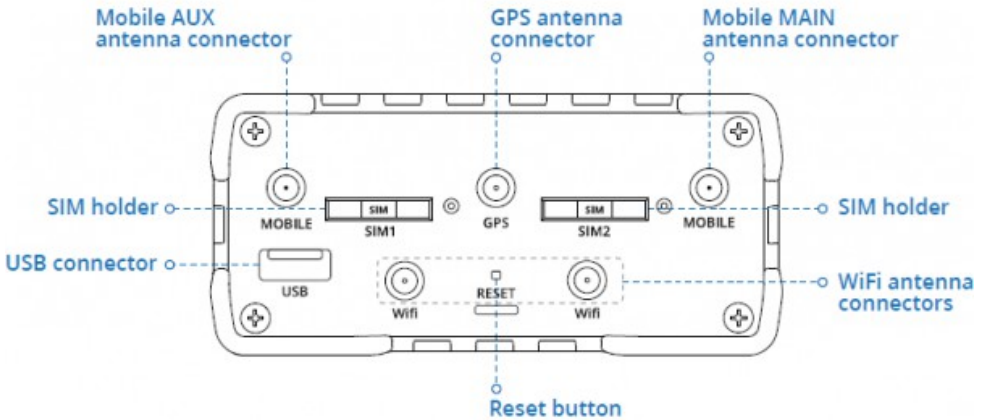

Power connector:

No	Description	Wire-color
1	+9 – 30V DC	Red
2	0V	Black
3	E/A	Green
4	E/A	White

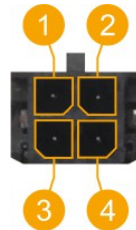

Hardware-installation

1.) Remove the SIM card slot tray(s) with the pin needle. Insert your SIM card(s) and push the tray(s) back into the router. Correct SIM card orientation can be seen in the figure below :



- 2.) Attach LTE, WiFi and GPS antennas
- 3.) Connect the power adapter to the power socket located on the front panel of the device. Then plug the other end of the power adapter into a power outlet.
- 4.) Connect to the CONNECT-CONTROL-device wirelessly or use an Ethernet cable.

Computer-configuration (Windows):

- 1.) Enable the wireless network connection (go to **Start** → **Control Panel** → **Network and Internet** → **Network and Sharing Center**. In the left panel click the **Change adapter settings** link. Right click on **Wireless Network Connection** and select **Enable**).

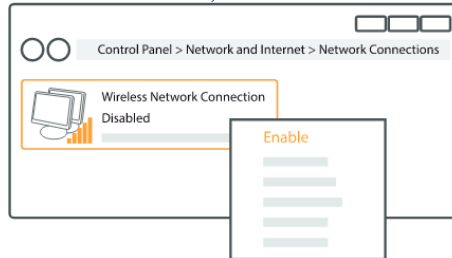

- 2.) Setup wireless network adapter on your computer (right click on **Wireless Network Connection** and select **Properties**. After that select **Internet Protocol Version 4 (TCP/IP)** and click **Properties**).
- 3.) Select **Obtain IP address** and **Obtain DNS server address automatically** if they are not selected. Click **OK**.

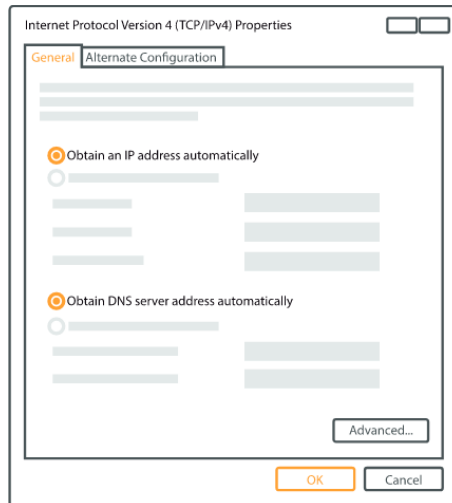

- 4.) Right click on **Wireless Network Connection** and select **Connect** to see available wireless networks.



- 5.) Choose the wireless network **RUT955_****** from the list and click **Connect**. Enter the WiFi password located on the device's label

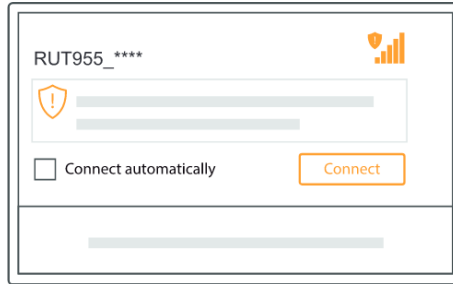

RUT955_****

Connect automatically Connect

First commissioning:

- Connect laptop to this WiFi network or LAN-cable in one of the 3 LAN-port and open with browser webserver with IP: <http://192.168.1.1>:

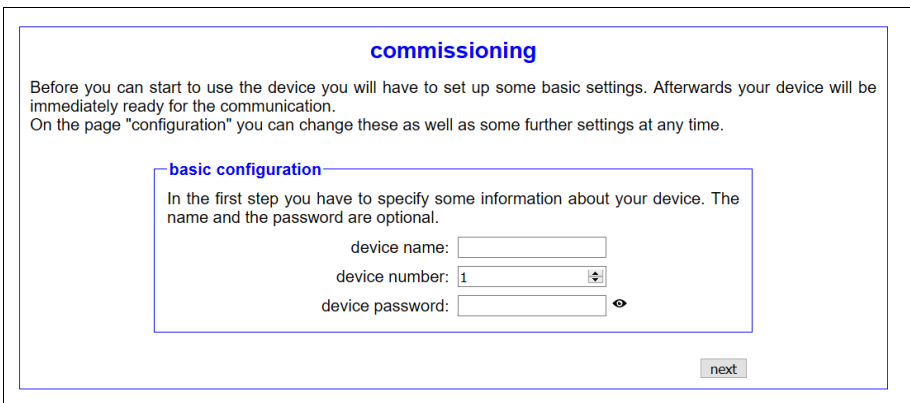

commissioning

Before you can start to use the device you will have to set up some basic settings. Afterwards your device will be immediately ready for the communication.
On the page "configuration" you can change these as well as some further settings at any time.

basic configuration

In the first step you have to specify some information about your device. The name and the password are optional.

device name:

device number:

device password:

next

internet configuration:

- **CONNECT** (uses the internet connection of the connected PC)

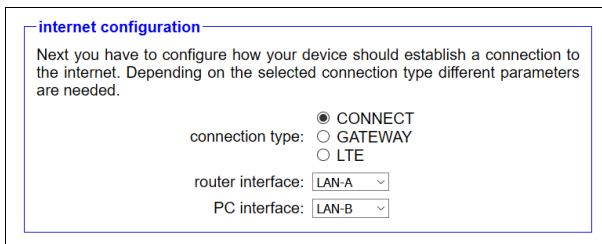

internet configuration

Next you have to configure how your device should establish a connection to the internet. Depending on the selected connection type different parameters are needed.

connection type: CONNECT
 GATEWAY
 LTE

router interface:

PC interface:

- Gateway (uses own ip-address for internet connection)

internet configuration

Next you have to configure how your device should establish a connection to the internet. Depending on the selected connection type different parameters are needed.

connection type: CONNECT
 GATEWAY
 LTE

router interface: LAN-A

IP settings

IP configuration: DHCP
 manually

IP address:

subnet mask:

internet access: gateway
 proxy server

gateway address:

- LTE (uses LTE for the internet connection)

internet configuration

Next you have to configure how your device should establish a connection to the internet. Depending on the selected connection type different parameters are needed.

connection type: CONNECT
 GATEWAY
 LTE

LTE settings

PIN code: 

access point (APN): internet

Peculiarity: The APN "internet" is standard for most providers, but can be changed if necessary

peripheral configuration:

- CONNECT + GATEWAY

peripheral configuration

Here you can select the interface and configure the addresses for the devices (e. g. from a PLC) who can communicate with the devices or the PC from the partner device. When using the connection type CONNECT this step is optional.

interface:

devices

IP addresses: +

IP address ranges: + -

- LTE

peripheral configuration

Here you can select the interface and configure the addresses for the devices (e. g. from a PLC) who can communicate with the devices or the PC from the partner device. When using the connection type CONNECT this step is optional.

interface:

IP settings

IP configuration: DHCP
 manually

DHCP server: enable

IP address:

subnet mask:

devices

IP addresses: +

IP address ranges: + -

partner configuration:

partner configuration

In the last step you can specify to which of your other devices the current device should establish a connection automatically. A connection can also be established if necessary via the page "overview".

connection: establish automatically

number:

password:

Explanation of parameters:

- device name: Device name (max. 15 characters)
- device number: Device number (1-65535) for assigning the connection
(no double device numbers allowed, please note !)
- router interface: Interface of the CONNECT-CONTROL to the Internet router
(depending on the Internet configuration, only sensible possible interfaces are displayed)
- PC interface: Interface of the CONNECT-CONTROL to the internet-compatible PC

Web interface (after first configuration):

Open the CONNECT web interface by clicking "<http://192.168.1.1>" in your browser with an active WIFI-connection. Or connect your PC to the in the first-configuration specified PC-interface using a LAN-cable and enter "CONNECT" in the address-line of the browser.

Click on the 3 stripes in the top left to open the device menu :

- Overview
- State
- Configuration
- Firmware update

Menu overview (overview of the device) :

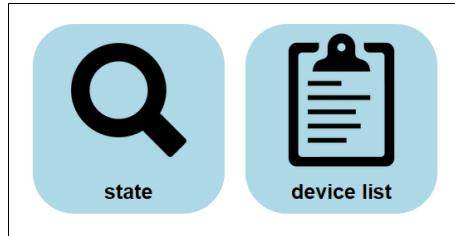

The menu is divided into status and device list. Clicking on the respective area opens a corresponding window. All other menus are shown in this menu frame .

The status display shows parameters of the connection, error messages and information about the connected devices :

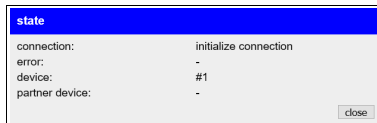

The Device list menu shows all devices available in your cloud. You can also establish and end connections to the other devices.

The status menu shows information about the IP / MAC addresses of the connection and information about the device:

system	device type: CONNECT LTE firmware version: 1.00 serial number: - customer ID: 815
device	name: - number: 1
interfaces	connection type: none
LTE interface	IMEI number: - ICCID number: - SIM state: - network state: - network operator: - network type: - signal: - IP state: - MAC address: -
LAN-A interface	state: not connected MAC address: c4:93:00:0b:0c:78
LAN-B interface	state: not connected MAC address: c4:93:00:0b:0c:79
WLAN interface	state: connected MAC address: c4:93:00:0b:0c:77 BSSID: - SSID: CONNECT WiFi channel: 1 signal: - IP address: 192.168.1.1 subnet mask: 255.255.255.0 gateway: - DNS server: -
USB-LAN interface	state: connected MAC address: 00:0e:c6:b2:ed:2f IP address: 192.168.0.1 subnet mask: 255.255.255.0 gateway: - DNS server: -

In the Configuration menu, the expert configuration will be carried out differently from the quick commissioning of the device. For example, you can set the DHCP mode, set IP addresses, and carry out the basic configuration of the device again.

The status menu shows information about the IP / MAC addresses of the connection and information about the device:

system	device type: CONNECT LTE firmware version: 1.00 serial number: - customer ID: 815
device	name: - number: 1
interfaces	connection type: none
LTE interface	IMEI number: - ICCID number: - SIM state: - network state: - network operator: - network type: - signal: - IP state: - MAC address: -
LAN-A interface	state: not connected MAC address: c4:93:00:0b:0c:78
LAN-B interface	state: not connected MAC address: c4:93:00:0b:0c:79
WLAN interface	state: connected MAC address: c4:93:00:0b:0c:77 BSSID: - SSID: CONNECT WiFi channel: 1 signal: - IP address: 192.168.1.1 subnet mask: 255.255.255.0 gateway: - DNS server: -
USB-LAN interface	state: connected MAC address: 00:0e:c8:b2:ed:2f IP address: 192.168.0.1 subnet mask: 255.255.255.0 gateway: - DNS server: -

In the Configuration menu, the expert configuration will be carried out differently from the quick commissioning of the device. For example, you can set the DHCP mode, set IP addresses, and carry out the basic configuration of the device again.

system

device family: CONNECT
 device type: CONNECT CONNECT LTE
 serial number:
 customer number: 815
 server address: 93.240.109.115
 server port: 443

access protection

current config password:

config password

change password: change password
 new password:
 repeat new password:

general

restart:
 default settings:
 factory default:
 support request:

device

name:
 number: 1
 password:

partner device

connection: establish automatically
 number: 1
 password:

interfaces

none
 CONNECT
 GATEWAY
 LTE

LTE settings

PIN code:
 access point (APN): internet

LAN-A settings

MAC address: c4:93:00:0b:0c:78
 DHCP mode:
 IP address:
 subnet mask:
 gateway:
 DNS server:

LAN-B settings

MAC address: c4:93:00:0b:0c:79
 DHCP mode:
 IP address:
 subnet mask:
 gateway:
 DNS server:

WLAN settings

deactivate WLAN: deactivate WLAN
 MAC address: c4:93:00:0b:0c:77
 DHCP mode: DHCP server
 IP address: 192.168.1.1
 subnet mask: 255.255.255.0
 gateway:
 DNS server:

search:
 mode: Access Point (AP)
 SSID: CONNECT.WIFI
 security type: open
 password:
 hide SSID: hide SSID
 channel: 1

USB-LAN settings

MAC address: 00:0e:c6:b2:ed:2f
 DHCP mode: DHCP server
 IP address: 192.168.0.1
 subnet mask: 255.255.255.0
 gateway:
 DNS server:

In the Firmware Update menu, the firmware of the CONNECT-CONTROL-device is updated.

firmware update

device version: 1.00
 firmware file: Keine Datei ausgewählt.

To do this, download the current firmware file to your PC from the product page. With Browse you select this file and accept it. The file name is displayed in the user interface for checking. By clicking Update firmware, the firmware file is loaded into the device and burned to the flash memory after a positive check. The device then restarts.

You can find more about the product and the current device manual on the product page of the CONNECT-CONTROL-device.

Menutree Website:

- + Products / docu / downloads
- + Hardware
- + Remote maintenance
- + S5
- + Internet
- + CONNECT devices
- + CONNECT-CONTROL
- + CONNECT-CONTROL World-LTE

QR-Code Website:



Please make sure to update your drivers before using our products.

Operation as an access point

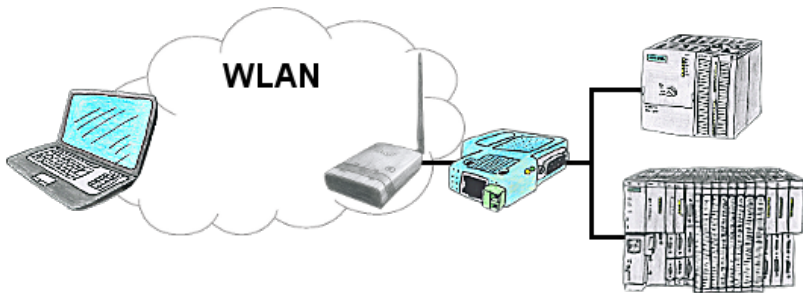

You are on site your plant and should move round the machine and simultaneously control or monitor. No problem, you parametrize ALF as an access-point and connect your S7-LAN or other network-client to him, connect your PC with him and you are online on the PLC.

PD-interface of the S5-PLC already occupied

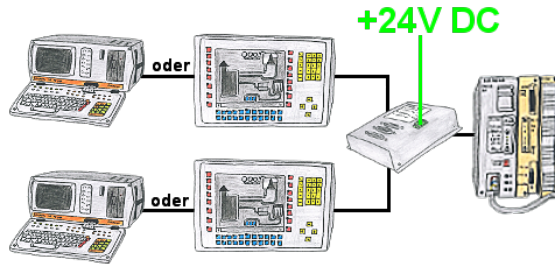

Your PD-interface of the S5-PLC is already occupied with a panel and you should accomplish program modifications without removing the panel? No problem, connect the Multiplexer one-time to the PLC and then connect the panel and also your PC to the Multiplexer. Now you can work parallel with the PLC without the need of affecting the operation of the panel. You can even work with 2 programming devices simultaneously, 2x open the same block, only changes which are stored at last will be finally stored in the PLC. Also ideal for trainings purposes if PLC's with IO's are scare goods.

The 24V-version is ideal for control-cabinet-installation due to the smaller footprint. A universal multiplexer no matter what you connect at the two PG-sockets, both participants communicate parallel with the control.

Operation on DSL-cable-modem

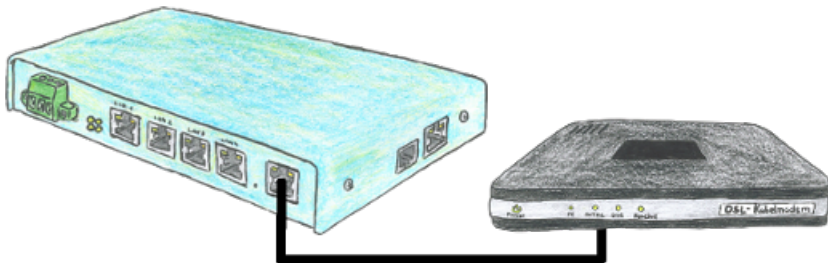

You are looking for a device which can be operated even with DSL? No problem, just plug in your TELE-router to a DSL cable modem, enter the parameters relating to the access data into the device and you are connected to Internet.